



**ELECTRIC BLANKET
INSTRUCTIONS**

**FITTED FLEECY
Adjustable Timer 3, 6, 9 & 12 Hour**

Model Number

900223

1 IMPORTANT SAFEGUARDS3
2 Securing Your Electric Blanket5
 2.1 Fitted.....5
3 Connecting the Controller.....6
4 Using The Controller7
 4.1 Indicator Lights7
 4.1.1 Heat Settings – Four LED Indicator7
 4.1.2 Timer Settings – Four LED Indicators (Green).....7
5 Auto Off 12-Hour Timer9
6 Overheat Protection9
7 Recommended Cleaning Instructions..... 10
 7.1 Treatment For Localised Soiling..... 10
 7.2 Hand Washing (Recommended) 10
 7.3 Machine Washing..... 10
 7.4 Drying 11
8 Servicing Your Blanket and Controller/s 11
9 Warranty 12

Thank you for purchasing our Electric Blanket. Each unit is manufactured to ensure safety and reliability. Before using for the first time, please read the instruction manual carefully and keep it for future reference.

1 IMPORTANT SAFEGUARDS

- Before connecting and switching on the blanket, ensure that the voltage indicated on the rating label corresponds to the mains voltage in your home.
- Read the instructions carefully, in conjunction with the illustrations, before fitting the blanket and using for the first time.
- If the cord of this blanket is damaged, unplug and discontinue use of the product then contact the manufacturer.
- Check daily that your blanket is flat, fully spread out and secured before switching it on.

Failure to observe these instructions will result in overheating. This will activate the overheat safeguard system, thus leaving the blanket inoperative.

Misuse of this blanket will invalidate your warranty.

- Use as an under-blanket only.
- These blankets are not recommended for futons.
- When storing the blanket, allow it to cool down before folding. Fold neatly but not tightly (or rolled) without sharp bends in the heating elements and store where no other heavy objects will be placed upon it.
- The blanket should not be used on an adjustable bed. However, if the blanket is used on an adjustable bed, check that the blanket and cord do not become trapped or rucked, for example, in hinges.
- The blanket is not to be used by young children unless the controls have been pre-set by a parent or guardian, or unless the child has been adequately instructed on how to operate the controls safely.
- Make sure that the heating area (on any side of the bed) does not fall over the edge of the mattress, that the attachments are adequate and suited to the mattress, and that the instructions are read before using the blanket.
- This blanket is not intended for use by young children or infirm persons without adequate supervision.
- Electric blankets are intended for human use only. Not for animals and pets
- Prolonged application at the highest heat setting can result in skin burns.
- Do not tuck the edges of the blanket in.
- Do not use the blanket rucked or folded.
- Keep the control away from an open window.

- Do not use pins as these may damage the electric wiring.
- Be sure that this blanket is used only on an alternating current supply circuit of the correct voltage.
- The flexible supply cord and switch must, as far as practicable, be kept outside of the bed covers.
- Do not switch the power on if the blanket is wet or in a folded state.
- Switch off the power outlet and remove the plug from the mains when the blanket is not in use.
- Bed clothes should not be folded back when the blanket is switched on. Do not leave heavy objects on the bed, e.g. folded blankets, suitcases etc. when the unit is switched on to the highest heat setting (pre-heat)
- Arrange the blanket so that the elements are not under the pillows and/or bolsters.
- Do not dry-clean this blanket. Cleaning liquid may have a damaging effect on the insulation covering of the heating unit. Follow washing directions located on the blankets rating label. (Foot end of the blanket) and in this Instruction Manual.
- Persons suffering from bed-wetting should not use this blanket.
- If any abnormality or defect in operation is observed, discontinue its use immediately and consult the distributor regarding its examination and/or repair.
- The blanket should be examined frequently for signs of wear, either of the blanket, controller or flexible cord. If wear is visible or if any abnormality or defect in operation in the blanket is observed, discontinue use immediately and consult a qualified and registered person for service.
- The blanket must not be used over or under a water bed.
- Depending on the controller type, you may notice a blue flash in the switch when moving from one setting to another. This is NOT dangerous and is caused by the copper parts making contact.
- It is recommended that your electric blanket is inspected by a qualified and registered person after 3 years of use.
- This blanket is intended for domestic use only. It is **not** intended for use in hospitals or the like.
- Do not switch on if the blanket is folded or wet.
- Switch off from the power outlet and remove plug when the blanket is not in use.
- Only use the controllers supplied with this blanket.

2 Securing Your Electric Blanket

2.1 Fitted

Note: Your electric blanket should be placed directly onto the mattress. If using a mattress protector, this goes over the electric blanket.

IMPORTANT:

- Place the blanket onto the mattress with the controller at the **HEAD end** of the bed.
- Electric blankets must **NOT** be used on top of the user (as with a normal blanket), instead they must be firmly secured to the mattress.
- Place blanket on the mattress and the power supply lead at the pillow end of the mattress. Ensure the heating elements **do not** extend under the pillows.
- Fit the side skirts around the edges of the mattress then use the elastic skirt to ensure that the blankets fits snugly around the sides and underneath the mattress.
- Spread the skirt around the mattress edge ensuring even tension and making sure the blanket is placed evenly over the mattress then ensure that the blanket is flat and crease free.

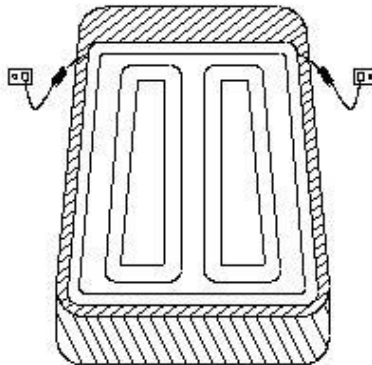

FAILURE TO FOLLOW THESE FITTING INSTRUCTIONS MAY TRIGGER THE OVERHEAT PROTECTION SYSTEM AND RENDER THE BLANKET PERMANENTLY INOPERATIVE. THIS MAY INVALIDATE THE WARRANTY.

- Care should also be taken if you are using a continental quilt because heat will build up more quickly than with other bed coverings. A short period may only be needed to reach maximum temperature depending on the insulation density of your quilt. This also applies if using additional bed blankets.

3 Connecting the Controller

Turn Off Power and Remove the Plug from the Wall Socket

- To fit the controller plug, simply hold the socket with one hand and push the controller plug all the way until the locking tab locates over the lug on top of the controller plug.
- To remove the controller, lift the locking tab up with your finger and pull the controller plug directly out. Do Not Pull the controller cable and Do Not try and pull the controller plug out without lifting the locking tab as you will damage the socket.

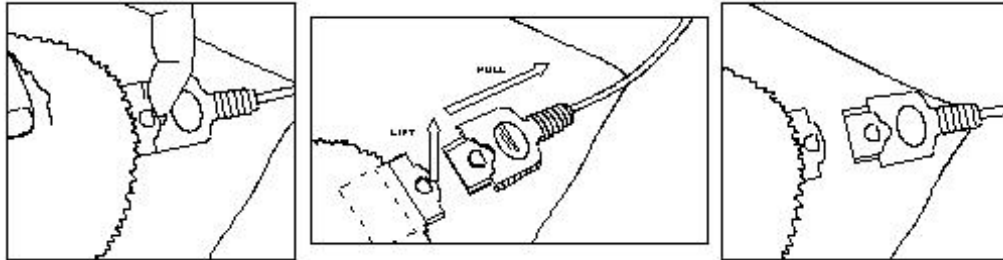

- Do Not fold, roll or kink the cable. Allow the cable to hang freely.
- Ensure the cable is not pulled so tight that it bends hard at the blanket connector end.
- Make your bed in the usual manner.
- Ensure that the electric blanket is sized to suit your mattress i.e. queen sized electric blanket must be used on a queen sized mattress. Do not use a single bed blanket on a double, queen or king size mattress. **The blanket top must not hang over the edges of the mattress.**
- The blanket's electrical area (element) must not be positioned under the pillow area. The position of the element within the blanket is designed to provide an even, all over warmth for the remainder of the bed surface.
- The blanket top should not be tucked in at the sides.
- When you are satisfied that the blanket is fitted correctly, plug the controllers into the wall power socket and turn on.

4 Using The Controller

Use your Electric Blanket with Detachable Controller Model GW420/1 Only.

Do not use any other controller for this blanket.

The two push buttons on the controller are backlit for easy viewing at night.

The buttons will be illuminated when pressed and the lights will time out after five seconds.

4.1 Indicator Lights

Top button operates the heat settings.

Lower button operates the timing settings.

4.1.1 Heat Settings – Four LED Indicator

- Blue Power On
- Green All Night (Low)
- Amber All Night (Medium)
- Red Pre Heat (High)

4.1.2 Timer Settings – Four LED Indicators (Green)

- One Light Three Hours Auto Off
- Two Lights Six Hours Auto Off
- Three Lights Nine Hours Auto Off
- Four Lights Twelve Hours Auto Off (Default Setting)

When the controller has timed out, the blanket will revert to the “0” power available setting.

To reset the timer, press the timer button to the desired time. Alternatively the blanket will default back to the 12 hour setting by adjusting the heat level.

When the Power On is pressed, the timer setting will automatically go to Twelve Hours Auto Off setting. This can be changed to Three, Six or Nine Hours Auto Off by pressing the timer button repeatedly.

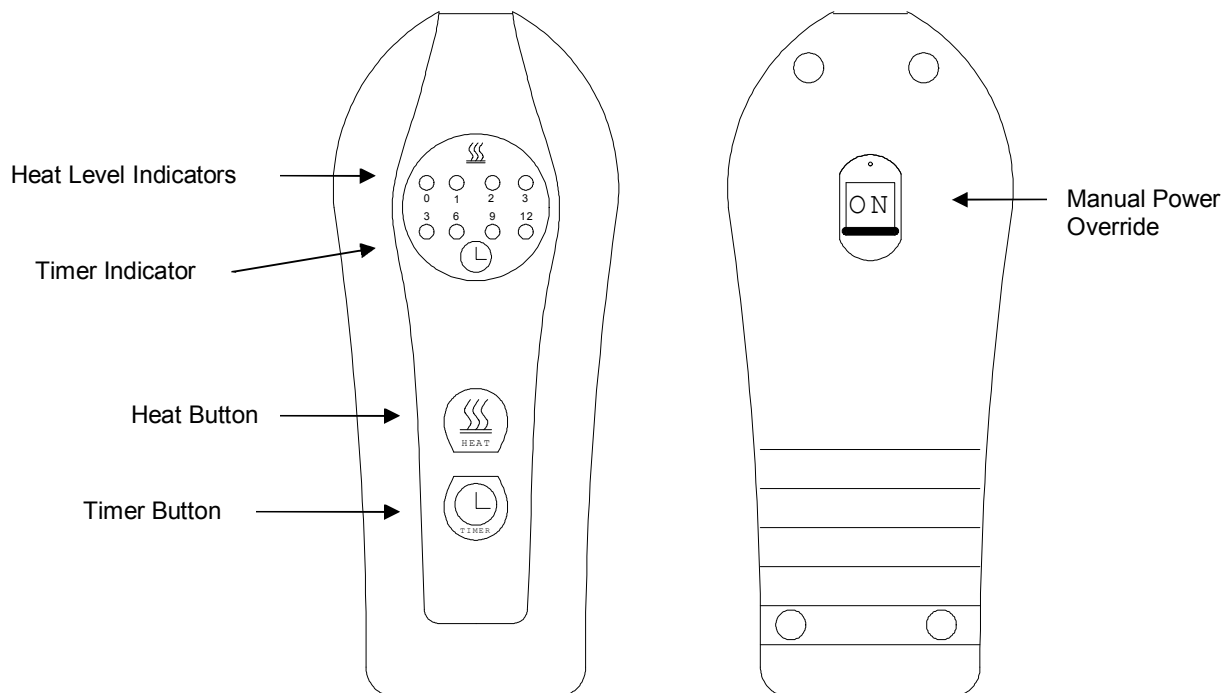

- Turn off the blanket when not in use for prolonged periods by sliding the ON/OFF switch, (located on the back of the controller), to the OFF position.
- The controller also has a pre-heat facility in order for you to warm your bed prior to getting in to it. The time taken to pre-heat the bed will depend on the ambient temperature of the bedroom and whether an electric blanket has been used to air the bed on a regular basis.
- At normal ambient temperature you should allow approximately 60 - 90 minutes on the level "3" setting indicated by the red light.
- A cold room or bed that has not been used for some time will require a greater length of time on the pre-heat.
- Should the controller be disconnected, power from the switch will be disconnected through the cable and socket after approximately one minute.
- The blanket must always be used with the controller switch supplied (or controllers if it is a dual control version).

5 Auto Off 12-Hour Timer

- Should you forget to turn your blanket Off, the controller has a 12 hour safety timer. This means the blanket will automatically switch off approximately 12 hours after the last adjustment was made to the controller.
- This controller has a 12 hour auto off default feature built into the controller and may be adjusted by using the timer adjustment button.
- When the controller has reached its auto off time the blanket will revert to the “0” setting indicating that power is still available. It is then resettable by pressing either button back to the blue zone: “Power available-no heat.”
- Each time the heat settings moves through the blue zone, the timer will be restarted from 0. i.e. if you have the blanket on the pre-heat then adjust to one of the all night settings, the power indicator will move via the blue “Power available-no heat led, hence resetting the timer to the original twelve hours.

Compulsory Warning

- If the supply cord is damaged, it must be discarded.
- Turn off the blanket when not in use for prolonged periods by unplugging from the power point.
- The controller has a pre-heat facility in order for you to warm your bed prior to getting in to it. The time taken to pre-heat the bed will depend on the ambient temperature of the bedroom and whether an electric blanket has been used to air the bed on a regular basis.
- A cold room or bed that has not been used for some time will require a greater length of time on the pre-heat.

6 Overheat Protection

- The blanket is fitted with an overheat safeguard system.
- This offers protection against overheating or damage to the elements by disengaging the power to the elements before overheating hazards occur.
- Should there ever be a problem with the heating element in the blanket, it will automatically close down the operation and the blanket will turn off.
- The switch must not be covered. The switch has built in protection, so that if the switch overheats, it will automatically close down the operation.
- Should this occur, the blanket will turn off. Consult the retailer for possible repair or replacement.

7 Recommended Cleaning Instructions

Ensure all controllers are unplugged from the power point and from the electric blanket before cleaning

7.1 Treatment For Localised Soiling

- The area affected should be sponged gently using a natural wool detergent or mild soap flakes dissolved in lukewarm water, followed by two consecutive spongings using clean, soap-free lukewarm water.
- Lightly compress the treated area between two towels to absorb excess water and then spread the blanket out flat to dry in a shady area. Do Not Wring the blanket.
- The connections to the blanket must be kept free of moisture.

7.2 Hand Washing (Recommended)

- Remove the controllers and place your blanket in lukewarm water (bathtub or large laundry tub is ideal) mixed with either a natural wool detergent or with mild soap flakes.
- Soak your blanket for approximately five minutes, and then gently squeeze the soapy water through the blanket.
- Rinse your blanket thoroughly with clean lukewarm water until no more suds are visible and allow water to drain off the blanket. Do Not Wring the blanket.

Note: With normal use it is recommended that you hand wash your blanket once a year.







7.3 Machine Washing

- Remove the controllers and place your blanket in the washing machine with either a natural wool detergent or with mild soap flakes.
- Set your machine to the Delicate Wool or Gentle cycle (without Spin Dry) and set the water temperature to warm (30°C Max). Do Not Wash with HOT water.
- When the cycle has finished, allow water to drain off the blanket Do Not Wring the blanket.

7.4 Drying

- Spread the blanket out on a clean surface (e.g. a large table) to dry in a shady area.
- Your blanket can also be dried on a clothes line provided the blanket is not creased or folded and as long as pegs are not used on the element areas of the blanket.

Note: The blanket must be thoroughly dried (including controller sockets) before being re-fitted to your bed.

<p>WARNING:</p> <p>DO read all instructions before use. DO use only as an under blanket. DO secure blanket to bed before use. DO only clean blanket as specified in the instruction book. DO have this electric blanket repaired and/or tested by an authorised agent. DO remove controller before washing blanket.</p> <hr/> <p>DO NOT use tucked in, folded or rucked. DO NOT use if wet. DO NOT insert needles or pins into blanket. DO NOT use with element or wired parts tucked in. DO NOT use with helpless persons, infants or persons sensitive to heat. DO NOT wash controller.</p>	<p> Do Not Bleach or use detergents with Bleach</p> <p> Do Not Iron</p> <p> Do Not Dry Clean</p> <p> Do Not Tumble Dry</p> <p> Hang on line only when excess water has been removed. Do Not Wring</p> <p> Machine Wash or Hand Wash Only.</p>
--	--

8 Servicing Your Blanket and Controller/s

NOTE: There are no user serviceable parts in this blanket.

- If the blanket is not operating correctly, please check the following:
 - You have followed the instructions correctly.
 - That all the required switches are set to the heating positions.
 - That the mains power supply is ON.
- If the blanket still does not work after checking the above, Consult the retailer for possible repair or replacement.
- If the retailer fails to resolve the problem and you need to return the blanket, we recommend that:
 - The unit is packed carefully back into its original packaging.
 - Original proof of purchase is attached.
 - A note attached to the blanket explaining the reason why it is being returned.