



# **Piranha Mighty Power**

## **700W Hand Held Vac with Motorised Brush**



**MODEL NO: 900022**

## **IMPORTANT**

- Read this instruction booklet carefully before operation.
- Before using the appliance, check that the mains power voltage corresponds with the voltage shown on the rating plate.
- Always remove the plug from the power socket when the appliance is not in use and before carrying out any maintenance operations.
- Always remove the plug from the power socket before opening the appliance.
- Do not use the appliance to vacuum liquids, due to electric shock hazard.
- Do not use the appliance to vacuum sharp objects.
- Do not use the appliance to vacuum lighted cigarettes, hot ashes and any other combustible objects.



- Do not use the appliance to vacuum tiny particles like cement or plaster dust as this will shorten the life of the motor.
- Keep the vacuum cleaner away from stoves, heaters and any other heat emitting appliances. Heat can deform and discolour the plastic parts.
- Do not block the air flow. Blocking the suction in any way (e.g. blocked filters, blocked hose or full dust bag) will decrease the efficiency and will shorten the life of the motor.
- Do not run the vacuum cleaner over the power cable.
- Never leave the appliance unattended when it is switched on.
- The appliance is not intended for use by young children or infirm persons without supervision.
- Young children should be supervised to ensure that they do not play with the appliance.
- This appliance is for domestic use only. Commercial use voids warranty.
- Do not unplug by pulling the power cord. Always unplug by pulling the plug.
- Use as described in this instruction booklet.
- Do not switch the appliance on if it appears to be faulty in any way.
- For repairs or accessories contact the distributor on the contact details outlined in the guarantee.

## **DESCRIPTION**

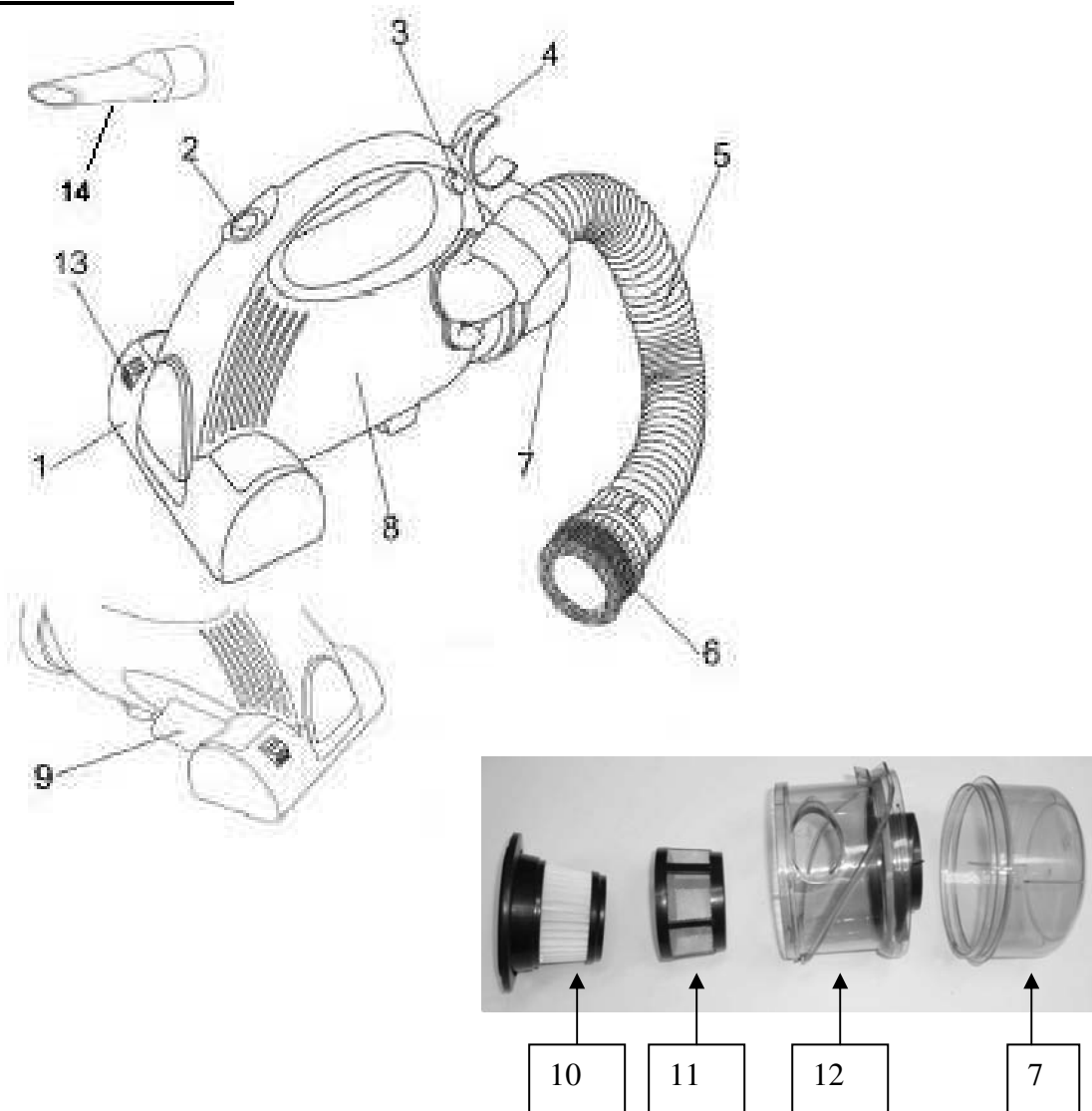

- 1 – Spinning Brush Safety Cover**
- 2 – On/Off Switch**
- 3 – Transparent Dirt/Dust container Release Button**
- 4 – Hose Clip**
- 5 – Flexible Hose**
- 6 – Retracting Brush**
- 7 - Transparent Dirt/Dust container**
- 8 – Main Unit**
- 9 – Hose Connector**
- 10 – HEPA Filter**
- 11 – Mesh Filter**
- 12 – Filter Container**
- 13 – Cover Rotating Knob**
- 14 – Crevice Tool**

## HEPA Filter and Cover:

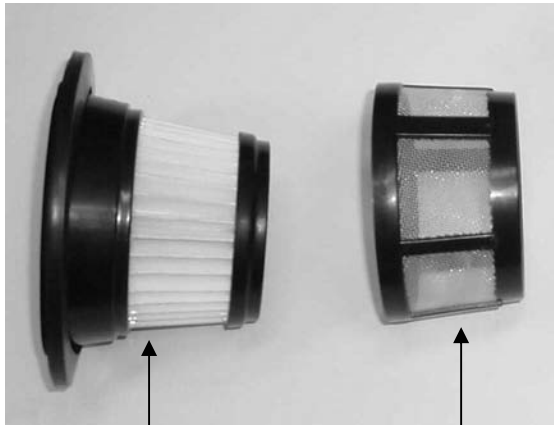

**HEPA FILTER**

**MESH FILTER**

**MESH Filter** – filters the larger particles of dirt.

**HEPA Filter** – HEPA stands for **H**igh **E**fficiency **P**articulate **A**ir, which means a very effective filter that can stop the smallest particle of dust, pollen, bacteria etc. from becoming an airborne allergen.

## HEPA Filter Housing and Dirt/Dust Container:



**Dismantled Filters and dirt container.**



**Assembled filter and dirt container**

## **ASSEMBLING THE VACUUM CLEANER**

*Please Note: Always remove the plug from the power socket before fitting or removing accessories*

### **Fitting the Dirt Container in Place**

Fit the Dirt Container in place by inserting the bottom part KNOB first and then pushing it in and up till it locks (clicks) into place.

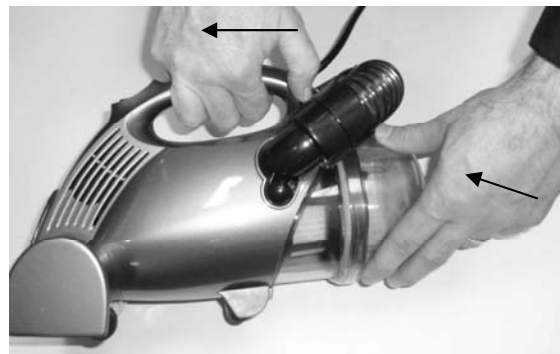
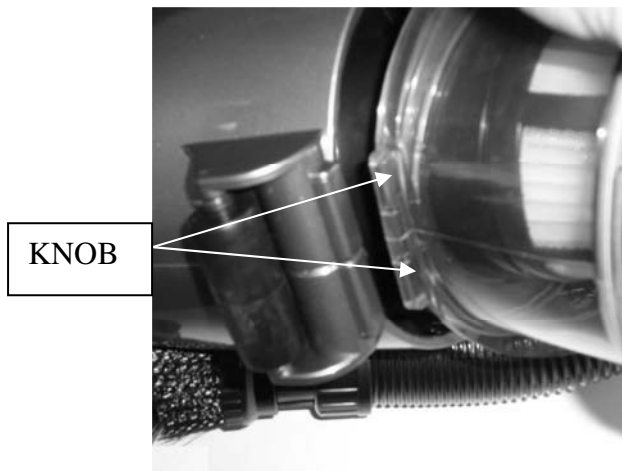

### **Fitting the Extendable Hose**

Insert the flexible hose into the hose clip and insert the other end of the hose into the connector



## **OPERATION METHOD**

***For your safety: Always keep your fingers away from the fast spinning brush.***

### **Using the Hand Vacuum for Cleaning:**

When you have assembled the hand vacuum, it is ready to use. Just plug it to the power point and turn the On/Off switch into the On position. Hold the handle firmly and vacuum over the dirty area.

**The rotating brush is best suitable for cleaning carpets and sofas.**

The best method of cleaning non carpeted areas, corners, edges, drawers, curtains, shelves, books, inlaid furniture, lamps and other delicate or hard to reach objects **is to use the extendible hose and Crevice Tool.**



### **Cleaning with the Hose and Crevice Tool:**

- 1 – Push the Cover Rotating Knob down to cover the spinning brush.
- 2 – Pull the Extendible hose out of the hose clip and the hose connector.
- 3 – You can extend the brush tool at the end of the hose or insert the Crevice tool

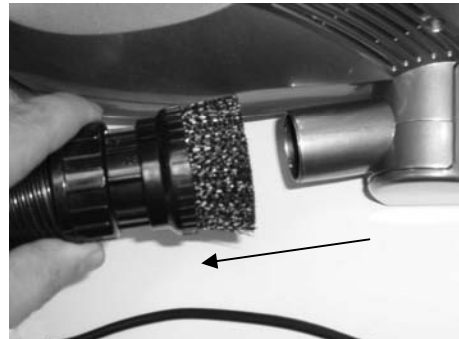

To use the Brush Tool, hold the hose in one hand and pull with the other hand and turn it clock wise to lock in place.

To use the Crevice Tool, just insert the Crevice Tool into the end of the hose.



## Turning the Vacuum Off

After you have finished cleaning, turn the vacuum off by pressing the On/Off Switch. Only then unplug the power plug from the power socket.

## MAINTENANCE

To Empty Dust/Rubbish Container, remove the Dirt/Dust container

### Removing the Dirt Container

To remove the Dirt Container, press the locking buttons on the back of the Handle release the lock and push the dirt container down from the top part first and then pull it away.

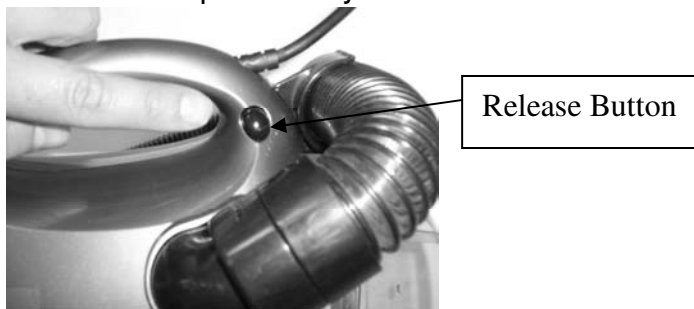

### Opening the Dirt container and emptying the rubbish

Hold it with 2 hands and twist in opposite direction as indicated by arrow in the photos below.

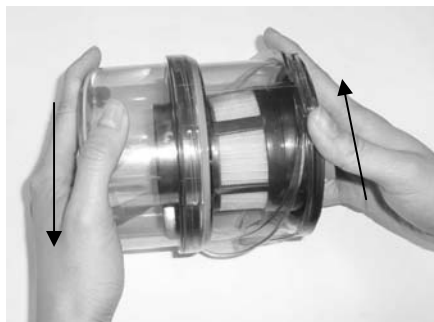

### Emptying the Dirt/Dust Container

Once you dismantle the Dirt/Dust container of the filter housing, simply empty the rubbish into a rubbish bin.



To  
Rubbish  
Bin

## Maintaining Filters

***Please Note: It is very important to keep the filters clean to receive maximum performance from the vacuum. Not cleaning / replacing your filters can reduce the suction power and cause overheating.***

### **Cleaning the the HEPA Filter and HEPA Filter Cover**

1. Remove the Heap Filter from the Housing

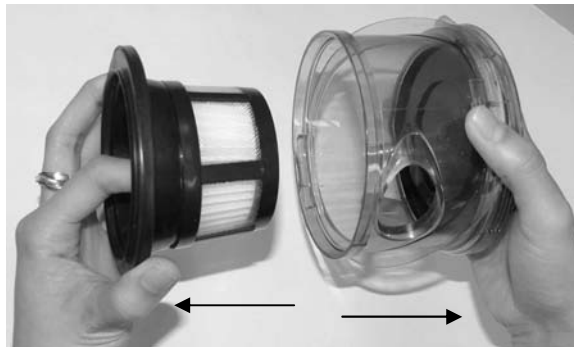
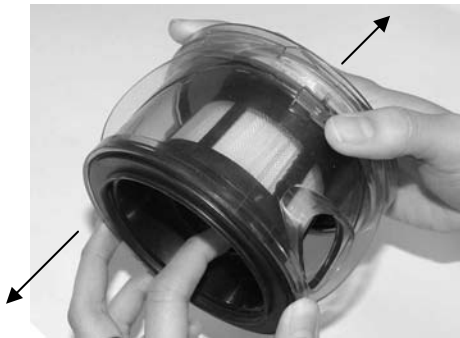

Remove the Mesh Filter Cover

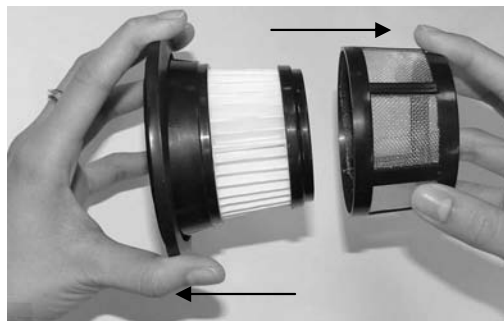
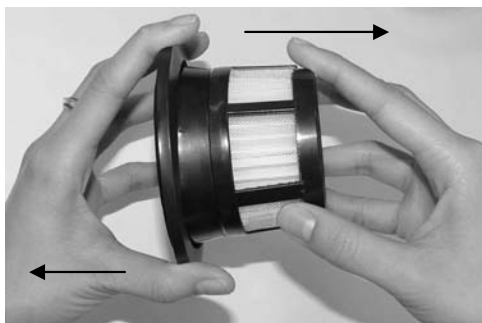

2. Wash the Mesh Filter and the HEPA Filter under running warm water. Allow the filters to dry completely before replacing it in the vacuum.



3. Filters should be maintained regularly to get maximum performance from the vacuum cleaner.
4. If filters are broken or worn, replace them before continuing to use the vacuum.
5. Filters can be purchased from the distributor or call Funtastic Customer Service on toll free 1800 660 665.

### **Cleaning the Vacuum**

1. Do not clean the vacuum using petrol or any other flammable liquid.
2. Clean only the outside of the vacuum cleaner.
3. Use only a moist cloth and detergent for cleaning the vacuum cleaner.
4. After cleaning, wipe off the moisture on vacuum cleaner with dry cloth.